

## BALL POINTS

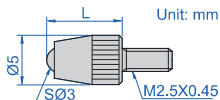

6282-0101

Code	Material of measuring face	L (mm)
6282-0101	carbide	7.3
6282-0103	ceramic	7.3
6282-0104	carbide	8.3
6282-0106	carbide	12.1
6282-0107	carbide	14
6282-0108	carbide	15
6282-0109	ceramic	15
6282-0110	carbide	17
6282-0111	carbide	19.3
6282-0112	carbide	20
6282-0113	ceramic	20
6282-0114	carbide	22
6282-0115	carbide	25
6282-0116	ceramic	25
6282-0117	carbide	30
6282-0118	ceramic	30

Code	Material of measuring face	L (mm)
6282-0119	carbide	35
6282-0120	ruby	35
6282-0121	carbide	40
6282-0122	ruby	40
6282-0123	carbide	45
6282-0124	ruby	45
6282-0125	carbide	50
6282-0126	ruby	50

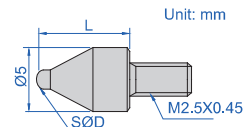

6282-0301

Code	Material of measuring face	SØD (mm)	L (mm)
6282-0301	steel	1	7.3
6282-0306	carbide	1	6
6282-0307	carbide	2	7
6282-0308	carbide	3	8
6282-0309	carbide	3.5	8.5
6282-0310	carbide	4	9
6282-0311	carbide	4.5	9.5
6282-0312	carbide	5.5	10
6282-0313	carbide	6	10.5
6282-0314	carbide	7	11.5



6282-0304

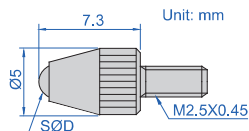

Code	Material of measuring face	SØD (mm)
6282-0302	carbide	1.5
6282-0303	carbide	1.8
6282-0304	carbide	2.5
6282-0305	carbide	4



6282-3407

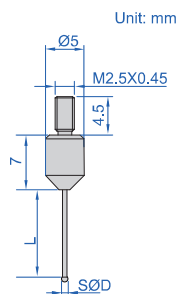

Code	Material of measuring face	L (mm)	SØD (mm)
6282-3401	ruby	10	1
6282-3402	ruby	20	1
6282-3403	ruby	30	1
6282-3404	ruby	40	1
6282-3405	ruby	50	1
6282-3406	ruby	10	2
6282-3407	ruby	20	2
6282-3408	ruby	30	2
6282-3409	ruby	40	2
6282-3410	ruby	50	2
6282-3411	carbide	10	1
6282-3412	carbide	20	1
6282-3413	carbide	30	1
6282-3414	carbide	40	1
6282-3415	carbide	50	1
6282-3416	carbide	10	1.5
6282-3417	carbide	20	1.5
6282-3418	carbide	30	1.5
6282-3419	carbide	40	1.5
6282-3420	carbide	50	1.5

Code	Material of measuring face	L (mm)	SØD (mm)
6282-3421	carbide	10	2
6282-3422	carbide	20	2
6282-3423	carbide	30	2
6282-3424	carbide	40	2
6282-3425	carbide	50	2
6282-3426	carbide	10	2.5
6282-3427	carbide	20	2.5
6282-3428	carbide	30	2.5
6282-3429	carbide	40	2.5
6282-3430	carbide	50	2.5
6282-3431	carbide	10	3
6282-3432	carbide	20	3
6282-3433	carbide	30	3
6282-3434	carbide	40	3
6282-3435	carbide	50	3

## SHELL TYPE POINTS



6282-0202

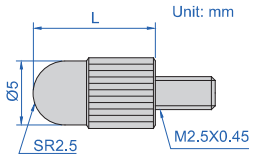

Code	Material of measuring face	L (mm)
6282-0202	steel	5
6282-0203	steel	10
6282-0205	steel	15
6282-0207	steel	20
6282-0208	steel	25
6282-0210	steel	30

## SPHERICAL POINT



6282-0401

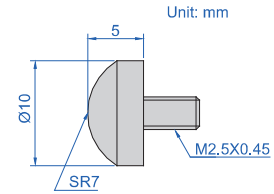

Code	Material of measuring face
6282-0401	steel

## CONICAL POINTS

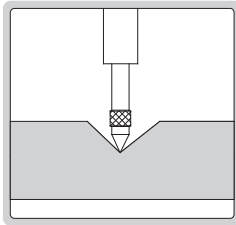

6282-0601

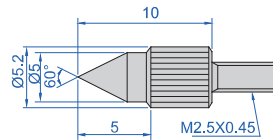

Code	Material of measuring face
6282-0601	steel
6282-0701	steel
6282-0801	steel
6282-0901	steel



6282-0701

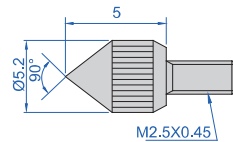

6282-0801

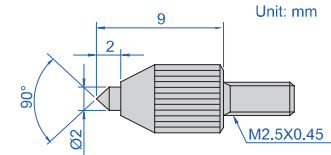

6282-0901

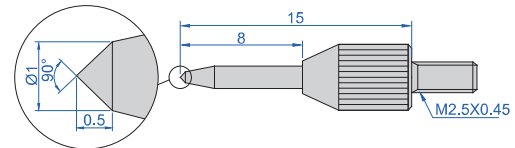

## FLAT POINTS



6282-1101

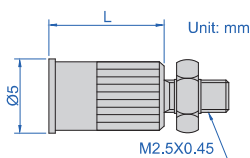
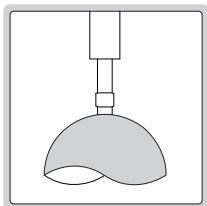

6282-1201

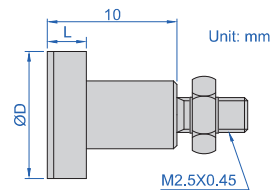

6282-1301

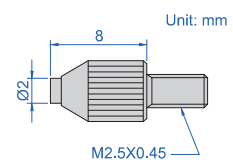

Code	Material of measuring face	L (mm)
6282-1101	steel	8
6282-1102	steel	10

Code	Material of measuring face	ØD (mm)	L (mm)
6282-1201	steel	10	3
6282-1202	steel	15	4
6282-1203	steel	20	3
6282-1204	steel	25	4
6282-1205	steel	30	3

Code	Material of measuring face
6282-1301	carbide

# FLAT POINTS

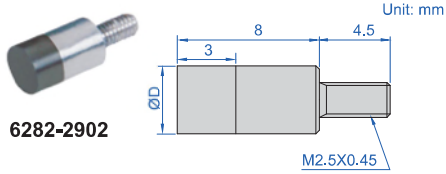

6282-2902

Code	Material of measuring face	ØD (mm)
6282-2901	carbide	4
6282-2902	carbide	5
6282-2903	carbide	6
6282-2904	carbide	8
6282-2905	carbide	10

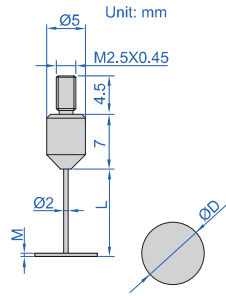

6282-3004

Code	Material of measuring face	L (mm)	M (mm)	ØD (mm)
6282-3001	carbide	13	0.4	3
6282-3002	carbide	13	0.4	4
6282-3003	carbide	13	0.4	5
6282-3004	carbide	13	0.4	6
6282-3005	carbide	13	1	6
6282-3006	carbide	33	0.4	6
6282-3007	carbide	13	0.4	8
6282-3008	carbide	13	0.4	10

# NEEDLE POINTS



6282-1711

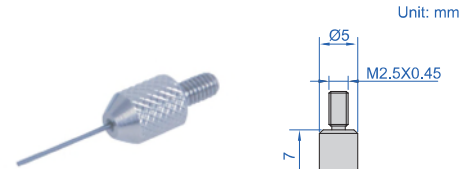
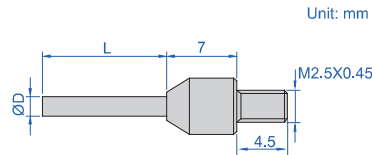

6282-3303

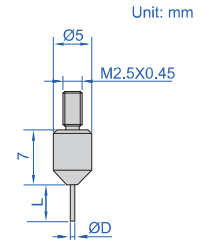

■ Material of measuring face: carbide

Code	Material of measuring face	ØD (mm)	L (mm)
6282-1701	steel	0.45	3
6282-1702	steel	0.45	5
6282-1703	carbide	1	3
6282-1704	carbide	1	5
6282-1705	carbide	1	8
6282-1706	carbide	1	10
6282-1707	carbide	1	20
6282-1708	carbide	1	40
6282-1709	carbide	1.5	5
6282-1710	carbide	1.5	10
6282-1711	carbide	1.5	13
6282-1712	carbide	1.5	20
6282-1713	carbide	1.5	40
6282-1714	carbide	2	8
6282-1715	carbide	2	18
6282-1716	carbide	2	28
6282-1717	carbide	2	40

Code	Material of measuring face	ØD (mm)	L (mm)
6282-1718	carbide	1	50
6282-1719	carbide	1.5	50
6282-1720	carbide	2	50
6282-1721	ceramic	1	10
6282-1722	ceramic	1	20
6282-1723	ceramic	1.5	10
6282-1724	ceramic	1.5	20
6282-1725	ceramic	1.5	30
6282-1726	ceramic	1.5	40
6282-1727	ceramic	1.5	50
6282-1728	ceramic	2	10
6282-1729	ceramic	2	20
6282-1730	ceramic	2	30
6282-1731	ceramic	2	40
6282-1732	ceramic	2	50

Code	ØD(mm)	L(mm)
6282-3301	0.5	3
6282-3302	0.5	5
6282-3303	0.5	10
6282-3304	0.6	10
6282-3305	0.7	10
6282-3306	0.8	10
6282-3307	0.9	10
6282-3308	1.2	10
6282-3309	0.5	15
6282-3310	0.6	15
6282-3311	0.7	15
6282-3312	0.8	15
6282-3313	0.9	15
6282-3314	1.2	15
6282-3315	0.5	20
6282-3316	0.6	20
6282-3317	0.7	20
6282-3318	0.8	20
6282-3319	0.9	20
6282-3320	1.2	20

## NEEDLE POINTS



6282-1601

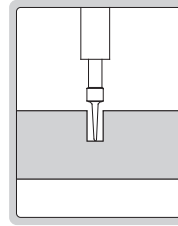
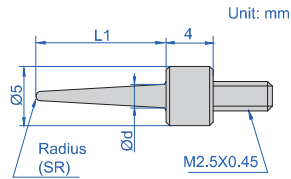

Code	Material of measuring face	L1 (mm)	Ød (mm)	SR (mm)
6282-1611	steel	7	2	0.15
6282-1612	steel	13	2	0.15
6282-1613	steel	22	2	0.15
6282-1614	steel	30	2	0.15
6282-1615	steel	40	2	0.15
6282-1602	steel	13	2	0.2
6282-1616	steel	50	2	0.2
6282-1617	steel	13	2	0.3
6282-1618	steel	17	2	0.3
6282-1619	steel	22	2	0.3
6282-1620	steel	30	2	0.3
6282-1621	steel	40	2	0.3
6282-1601	steel	11	2	0.4
6282-1603	steel	21	3	0.4
6282-1604	steel	31	3	0.4
6282-1622	steel	50	2	0.4

Code	Material of measuring face	L1 (mm)	Ød (mm)	SR (mm)
6282-1623	carbide	13	2	0.2
6282-1624	carbide	23	2	0.2
6282-1625	carbide	30	2	0.2
6282-1626	carbide	40	2	0.2
6282-1627	carbide	50	2	0.2
6282-1628	carbide	13	2	0.35
6282-1629	carbide	23	2	0.35
6282-1630	carbide	30	2	0.35
6282-1631	carbide	40	2	0.35
6282-1632	carbide	50	2	0.35

## KNIFE EDGE POINT

Code	Material of measuring face
6282-1001	steel

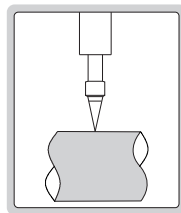

6282-1001

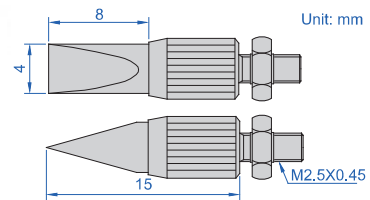

## BLADE POINTS

Code	Material of measuring face	D (mm)	W (mm)
6282-1801	steel	0.4	2
6282-1802	steel	0.6	2
6282-1803	steel	1	4

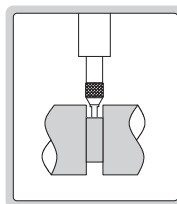

6282-1801

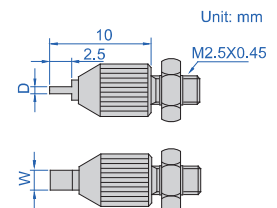

## ROLLER POINT

Code	Material of measuring face
6282-1901	steel



6282-1901

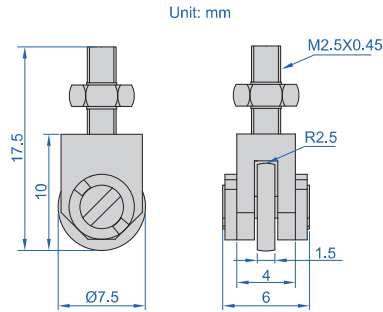

## EXTENSION RODS

Code	Material	L(mm)	Ød(mm)
6282-2001	steel	10	4
6282-2002	steel	15	4
6282-2003	steel	20	4
6282-2004	steel	25	4
6282-2005	steel	30	4
6282-2006	steel	35	4
6282-2007	steel	40	4
6282-2008	steel	45	4
6282-2009	steel	50	4
6282-2010	steel	55	4
6282-2011	steel	60	4
6282-2012	steel	65	4

Code	Material	L(mm)	Ød(mm)
6282-2013	steel	70	4
6282-2014	steel	75	4
6282-2015	steel	80	4
6282-2016	steel	90	4
6282-2017	steel	100	4
6282-2023	steel	150	5
6282-2024	steel	200	5
6282-2025	steel	300	5



6282-2010

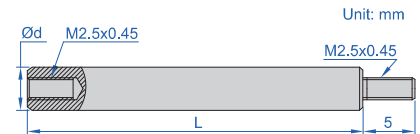

## POINT SET



6282-S6

Code	Material of measuring face
6282-S6	steel

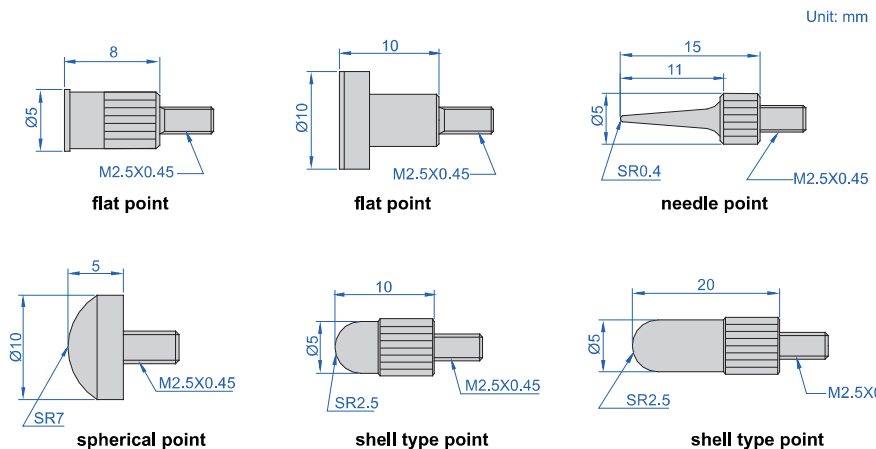

## PRECISION BALL POINTS



6282-3101

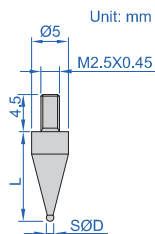

Code	SØD(mm)	L(mm)
6282-3101	1	12
6282-3102	1.5	12
6282-3103	2	12
6282-3104	2.5	12
6282-3105	3	12
6282-3106	3.5	12
6282-3107	4	12
6282-3108	4.5	12
6282-3109	5	12
6282-3110	5.5	12
6282-3111	6	12
6282-3112	6.5	12

Code	SØD(mm)	L(mm)
6282-3113	1	20
6282-3114	1.5	20
6282-3115	2	20
6282-3116	2.5	20
6282-3117	3	20
6282-3118	3.5	20
6282-3119	4	20
6282-3120	4.5	20
6282-3121	5	20
6282-3122	5.5	20
6282-3123	6	20
6282-3124	6.5	20

Code	SØD(mm)	L(mm)
6282-3125	1	30
6282-3126	1.5	30
6282-3127	2	30
6282-3128	2.5	30
6282-3129	3	30
6282-3130	3.5	30
6282-3131	4	30
6282-3132	4.5	30
6282-3133	5	30
6282-3134	5.5	30
6282-3135	6	30
6282-3136	6.5	30

- Material of measuring face: carbide
- Accuracy:  $\pm 2\mu\text{m}$



6282-3206

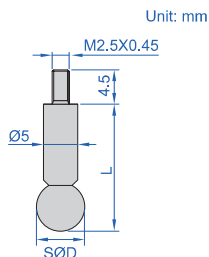

Code	SØD(mm)	L(mm)
6282-3201	7	20
6282-3202	7.5	20
6282-3203	8	20
6282-3204	8.5	20
6282-3205	9	20
6282-3206	9.5	20
6282-3207	10	20
6282-3208	10.5	20
6282-3209	11	20
6282-3210	12	20
6282-3211	13	20
6282-3212	14	20

Code	SØD(mm)	L(mm)
6282-3213	7	30
6282-3214	7.5	30
6282-3215	8	30
6282-3216	8.5	30
6282-3217	9	30
6282-3218	9.5	30
6282-3219	10	30
6282-3220	10.5	30
6282-3221	11	30
6282-3222	12	30
6282-3223	13	30
6282-3224	14	30

- Material of measuring face: carbide
- Accuracy:  $\pm 2\mu\text{m}$